

ROLL

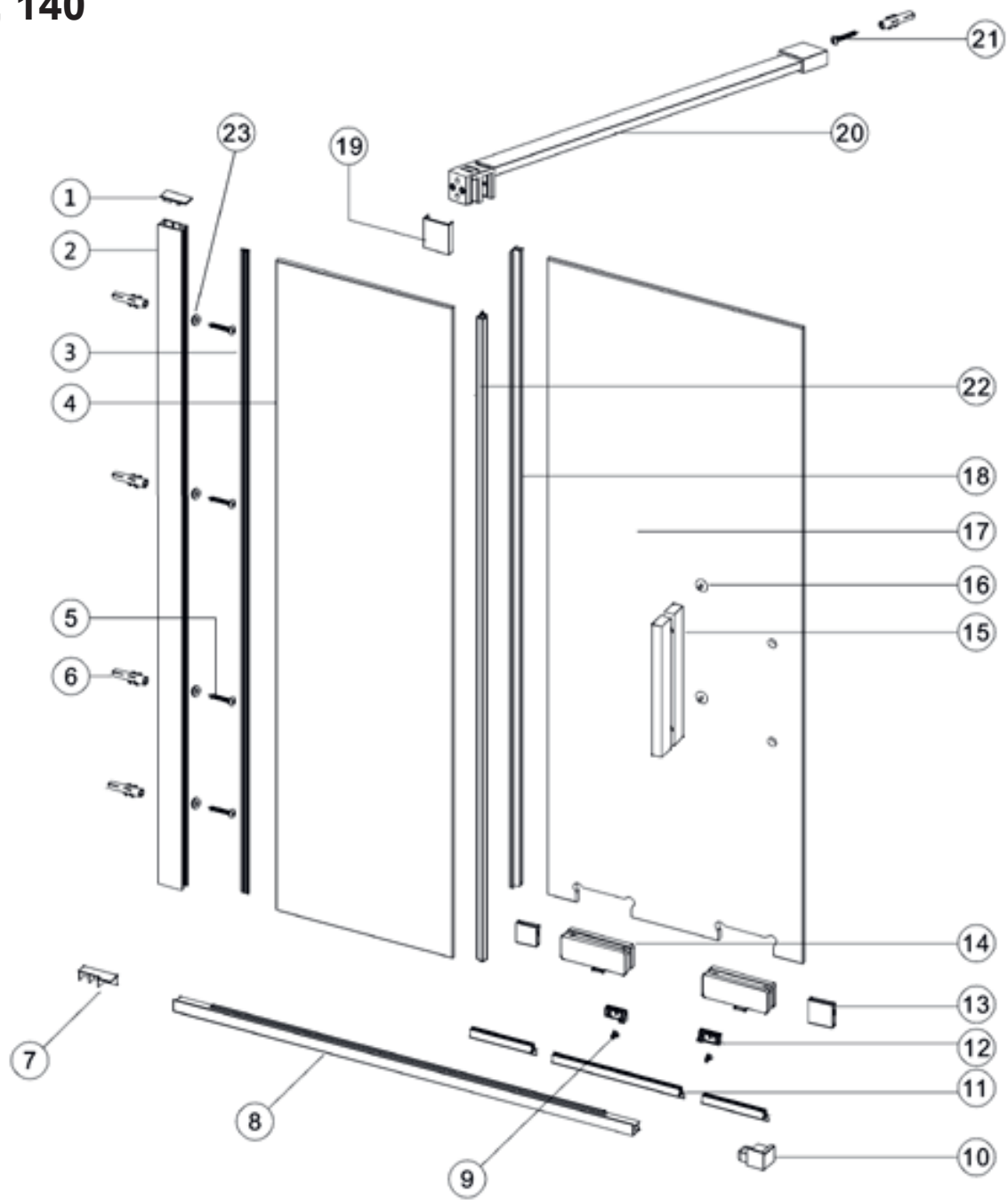









Katalog dílů







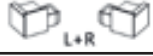





Platnost od 09/2025

RAVAK[®]

ROWI – 100, 110, 120, 140









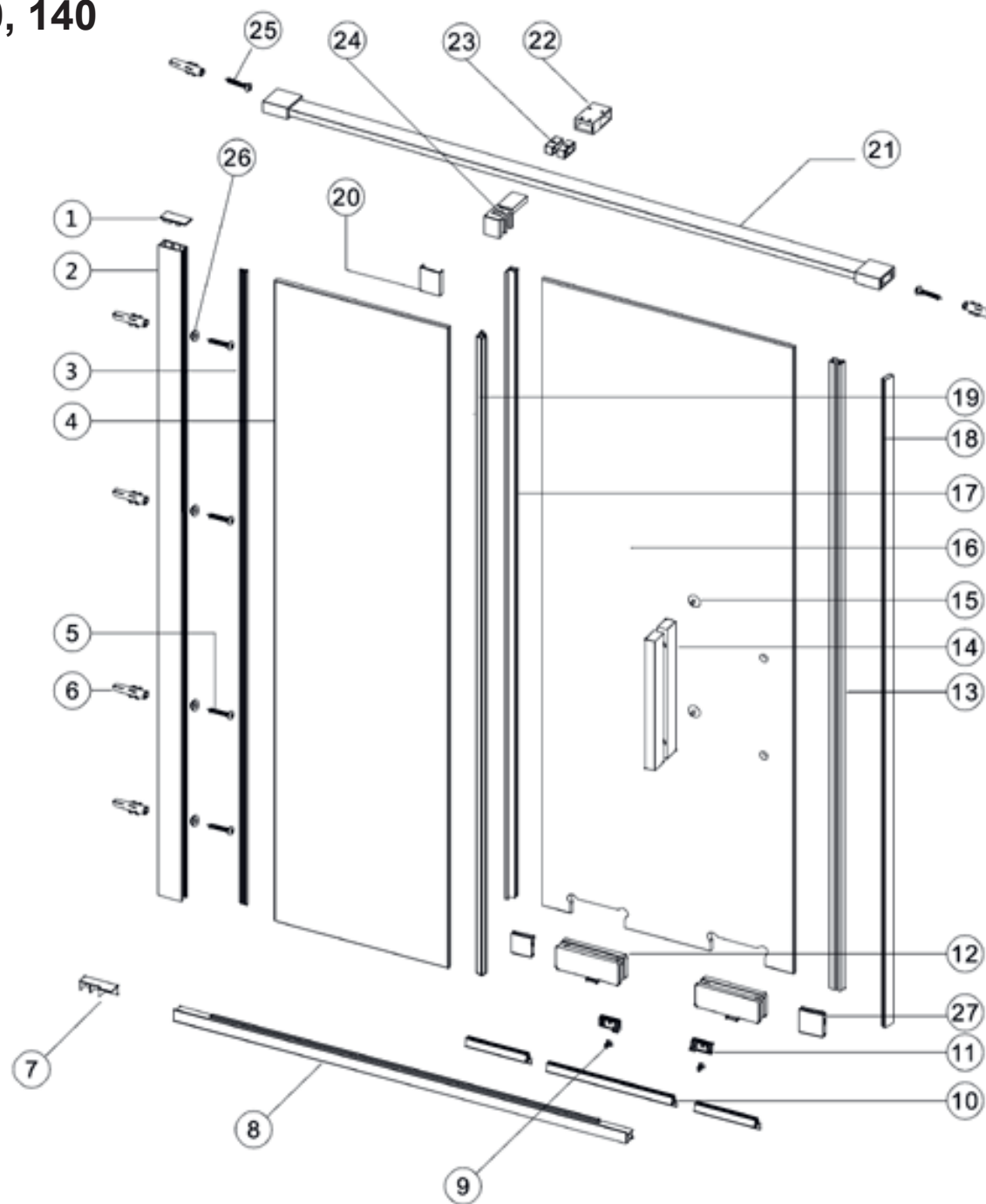

















| | ROWI – 100, 110, 120, 140 | | | | |
|-------------|-------------------------------------|----------------|-----------------|------------|---|
| Číslo dílu: | Název: | Množství [ks]: | SIČ bright alu: | SIČ black: | Obrázek: |
| 1 | krytka ustavovacího profilu LP-2140 | 1 | XND0000270 | XND0000344 |  |
| 2 | Ustavovací profil 1950 BRA-10612 | 1 | XND0000271 | XND0000345 |  |
| 3 | Těsnící profil skla 2000 LC-8799 | 1 | XND0000272 | XND0000346 |  |
| 4 | Sklo PS 100, 8-1947x490 LB-9035 | 1 | XND0000320 | |  |
| | Sklo PS 110, 8-1947x540 LB-9042 | 1 | XND0000321 | | |
| | Sklo PS 120, 8-1947x590 LB-9039 | 1 | XND0000322 | | |
| | Sklo PS 140, 8-1947x690 LB-9041 | 1 | XND0000323 | | |
| 5 | Vrut 4x30 LF-0214 | 4 | XND0000093 | |  |
| 6 | Hmoždinka 6 LP-8949 | 5 | XND0000061 | |  |
| 7 | Krytka vnitřní L,R LP-4639,LP-4640 | 1+1 | XND0000274 | XND0000347 |  |
| 8 | Vodící profil 100 BRA-10626 | 1 | XND0000273 | XND0000348 |  |
| | Vodící profil 110 BRA-10627 | 1 | XND0000307 | XND0000349 | |
| | Vodící profil 120 BRA-10628 | 1 | XND0000308 | XND0000350 | |
| | Vodící profil 140 BRA-10616 | 1 | XND0000309 | XND0000351 | |
| 9 | Šroub M4x6 LF-0059 | 2 | X90085040060 | |  |
| 10 | Rohová koncovka L,R LP-2990,LP-2989 | 1+1 | XND0000275 | XND0000352 |  |
| 11 | Okapnička 100 BRJ-4369 | 1 | XND0000276 | XND0000353 |  |
| | Okapnička 110 BRJ-4370 | 1 | XND0000312 | XND0000354 | |
| | Okapnička 120 BRJ-4372 | 1 | XND0000313 | XND0000355 | |
| | Okapnička 140 BRJ-4374 | 1 | XND0000314 | XND0000356 | |

| ROWI – 100, 110, 120, 140 | | | | | |
|----------------------------------|------------------------------------|----------------|-----------------|------------|--|
| Číslo dílu: | Název: | Množství [ks]: | SIČ bright alu: | SIČ black: | Obrázek: |
| 12 | Doraz kolečka L,R LP-2870,LP-2871 | 1+1 | XND0000277 | XND0000357 |  |
| 13 | U profil montážní LC-1244 | 2 | XND0000319 | |  |
| 14 | Pojezdové kolečko LL-8327 | 2 | XND0000278 | XND0000358 |  |
| 15 | Madlo dveří LS-8326 | 1 | XND0000279 | XND0000359 |  |
| 16 | Krytka madla LP-2965 | 2 | XND0000280 | XND0000360 |  |
| 17 | Sklo dveří 100, 8-1926x523 LB-9034 | 1 | XND0000331 | |  |
| | Sklo dveří 110, 8-1926x573 LB-9036 | 1 | XND0000332 | | |
| | Sklo dveří 120, 8-1926x623 LB-9038 | 1 | XND0000333 | | |
| | Sklo dveří 140, 8-1926x723 LB-9040 | 1 | XND0000334 | | |
| 18 | Těsnící profil dveří LC-1249 | 1 | XND0000281 | XND0000361 |  |
| 19 | Krytka vzpěry LP-2872 | 1 | XND0000282 | XND0000362 |  |
| 20 | Vzpěra BRP-4698 | 1 | XND0000283 | XND0000363 |  |
| 21 | Vrut 4x40 LF-0224 | 1 | X90085040094 | |  ST4x40 |
| 22 | Těsnící profil PS LC-1276 | 1 | XND0000284 | XND0000364 |  |
| 23 | Podložka pod vrut LP-2259 | 4 | XND0000090 | |  |

RODP2 – 100, 110, 120, 140











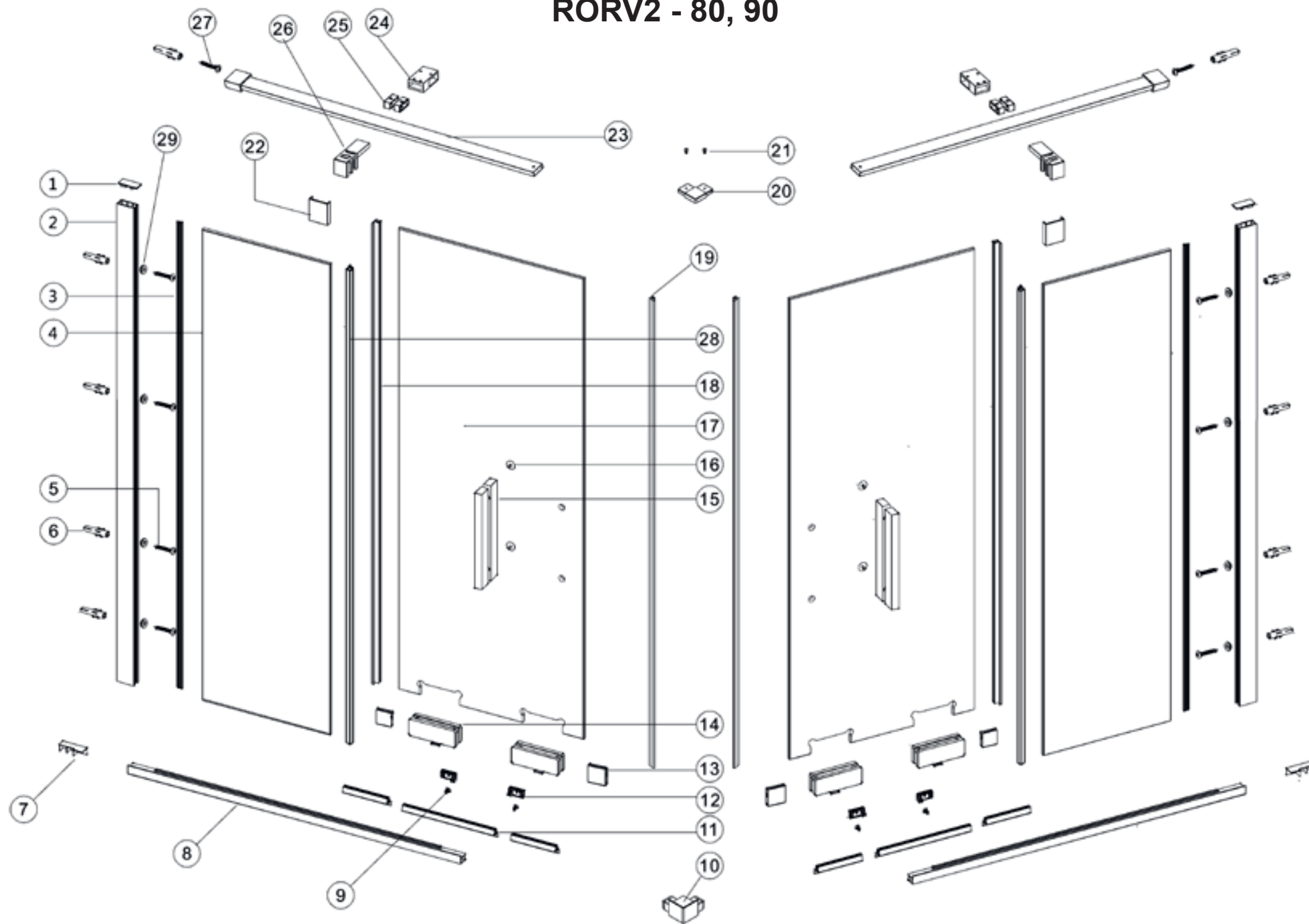





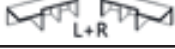

| RODP2 – 100, 110, 120, 140 | | | | | |
|-----------------------------------|-------------------------------------|----------------|-----------------|------------|---|
| Číslo dílu: | Název: | Množství [ks]: | SIČ bright alu: | SIČ black: | Obrázek: |
| 1 | krytka ustavovacího profilu LP-2140 | 1 | XND0000270 | XND0000344 |  |
| 2 | Ustavovací profil 1950 BRA-10612 | 1 | XND0000271 | XND0000345 |  |
| 3 | Těsnící profil skla 2000 LC-8799 | 1 | XND0000272 | XND0000346 |  |
| 4 | Sklo PS 100, 8-1947x490 LB-7853 | 1 | XND0000320 | |  |
| | Sklo PS 110, 8-1947x540 LB-7843 | 1 | XND0000321 | | |
| | Sklo PS 120, 8-1947x590 LB-7857 | 1 | XND0000322 | | |
| | Sklo PS 140, 8-1947x690 LB-7859 | 1 | XND0000323 | | |
| 5 | Vrut 4x30 LF-0214 | 4 | XND0000093 | |  |
| 6 | Hmoždinka 6 LP-8949 | 5 | XND0000061 | |  |
| 7 | Krytka vnitřní L,R LP-4639,LP-4640 | 1+1 | XND0000274 | XND0000347 |  |
| 8 | Vodící profil 100 BRA-10613 | 2 | XND0000285 | XND0000365 |  |
| | Vodící profil 110 BRA-10614 | 1 | XND0000310 | XND0000366 | |
| | Vodící profil 120 BRA-10615 | 1 | XND0000311 | XND0000367 | |
| | Vodící profil 140 BRA-10616 | 1 | XND0000309 | XND0000351 | |
| 9 | Šroub M4x6 LF-0059 | 2 | X90085040060 | |  |
| 10 | Okapnička 100-523 BRJ-4333 | 1 | XND0000286 | XND0000368 |  |
| | Okapnička 110-573 BRJ-4335 | 1 | XND0000315 | XND0000369 | |
| | Okapnička 120-623 BRJ-4338 | 1 | XND0000316 | XND0000370 | |
| | Okapnička 140-723 BRJ-4340 | 1 | XND0000317 | XND0000371 | |
| 11 | Doraz kolečka L,R LP-2870,LP-2871 | 1+1 | XND0000277 | XND0000357 |  |













| | RODP2 – 100, 110, 120, 140 | | | | |
|-------------|------------------------------------|----------------|-----------------|------------|---|
| Číslo dílu: | Název: | Množství [ks]: | SIČ bright alu: | SIČ black: | Obrázek: |
| 12 | Pojezdové kolečko LL-8327 | 2 | XND0000278 | XND0000358 |  |
| 13 | Profil dveří-magnet LC-8635 | 1 | XND0000287 | XND0000372 |  |
| 14 | Madlo dveří LS-8326 | 1 | XND0000279 | XND0000359 |  |
| 15 | Krytka madla LP-2965 | 2 | XND0000285 | XND0000360 |  |
| 16 | Sklo dveří 100, 8-1926x523 LB-7852 | 1 | XND0000331 | |  |
| | Sklo dveří 110, 8-1926x573 LB-7854 | 1 | XND0000332 | | |
| | Sklo dveří 120, 8-1926x623 LB-7856 | 1 | XND0000333 | | |
| | Sklo dveří 140, 8-1926x723 LB-7858 | 1 | XND0000334 | | |
| 17 | Těsnící profil dveří LC-1249 | 1 | XND0000281 | XND0000361 |  |
| 18 | Magnet-zed' 1934 LC-1275 | 1 | XND0000288 | XND0000373 |  |
| 19 | Těsnící profil PS LC-1276 | 1 | XND0000284 | XND0000364 |  |
| 20 | Krytka vzpěry LP-2872 | 1 | XND0000282 | XND0000362 |  |
| 21 | Vzpěra 100 BRP-4670 | 1 | XND0000289 | XND0000374 |  |
| | Vzpěra 110 BRP-4672 | 1 | XND0000303 | XND0000375 | |
| | Vzpěra 120 BRP-4673 | 1 | XND0000304 | XND0000376 | |
| | Vzpěra 140 BRP-4674 | 1 | XND0000305 | XND0000377 | |
| 22 | Konzola LW-1082 | 1 | XND0000290 | XND0000378 |  |
| 23 | Pouzdro na tyč LP-8967 | 2 | XND0000291 | XND0000379 |  |
| 24 | Podpora BRP-4669 | 1 | XND0000292 | XND0000380 |  |

| RODP2 – 100, 110, 120, 140 | | | | | |
|-----------------------------------|---------------------------|----------------|-----------------|------------|--|
| Číslo dílu: | Název: | Množství [ks]: | SIČ bright alu: | SIČ black: | Obrázek: |
| 25 | Vrut 4x40 LF-0224 | 2 | XND0000094 | |  ST4x40 |
| 26 | Podložka pod vrut LP-2259 | 4 | XND0000090 | |  |
| 27 | U profil montážní LC-1244 | 2 | XND0000319 | |  |

RORV2 - 80, 90









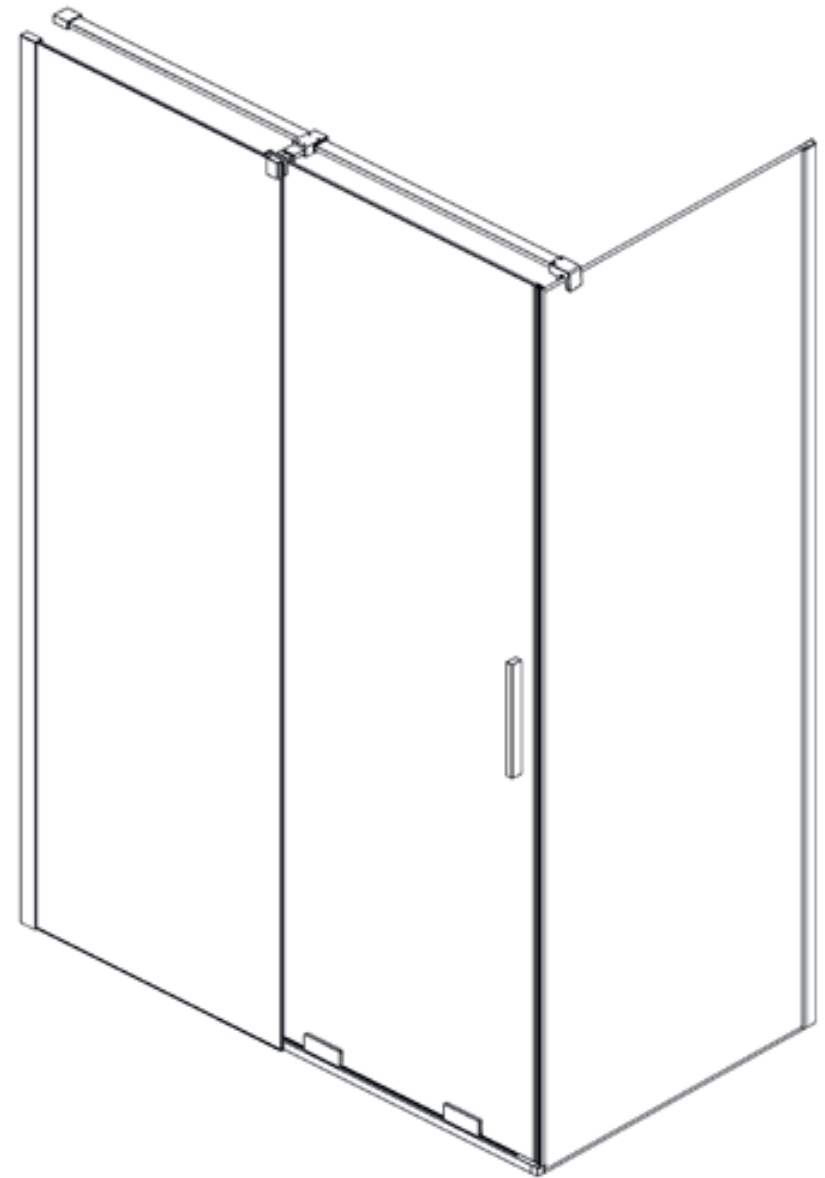
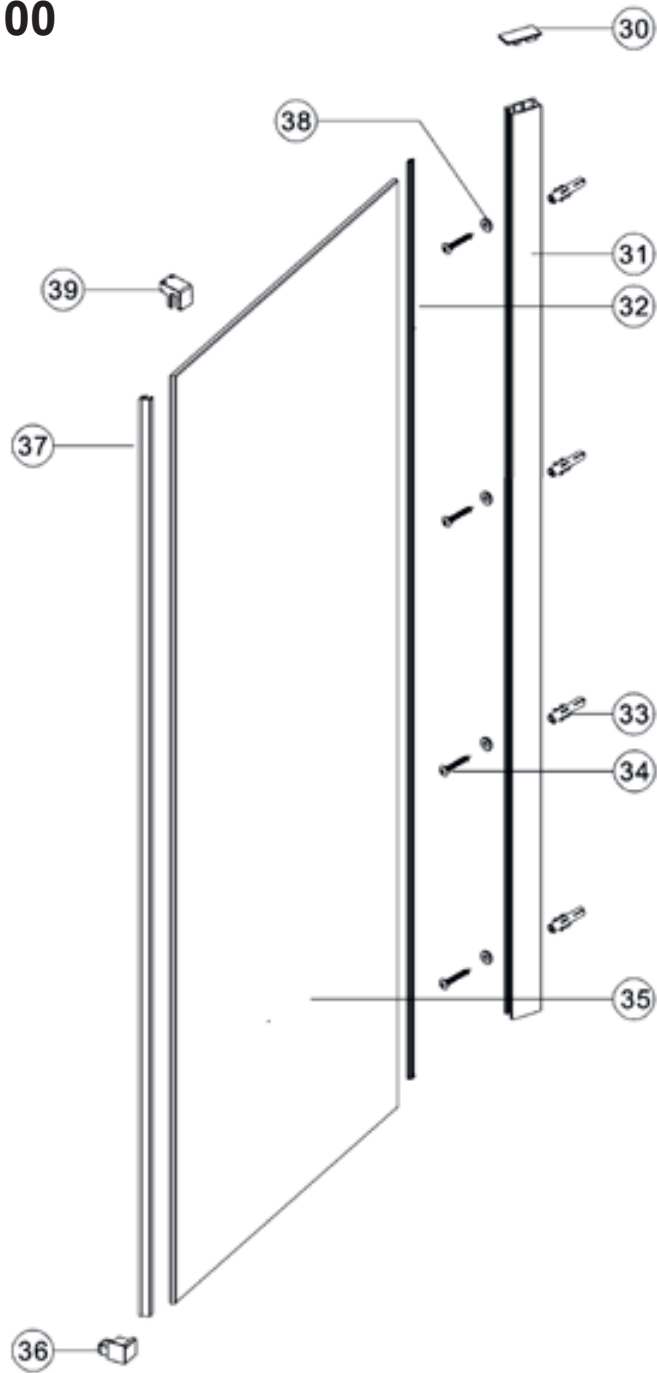



| RORV2 - 80, 90 | | | | | |
|-----------------------|-------------------------------------|----------------|-----------------|------------|---|
| Číslo dílu: | Název: | Množství [ks]: | SIČ bright alu: | SIČ black: | Obrázek: |
| 1 | krytka ustavovacího profilu LP-2140 | 1 | XND0000270 | XND0000344 |  |
| 2 | Ustavovací profil 1950 BRA-10612 | 1 | XND0000271 | XND0000345 |  |
| 3 | Těsnící profil skla 2000 LC-8799 | 1 | XND0000272 | XND0000346 |  |
| 4 | Sklo PS 80, 8-1947x370 LB-7861 | 1 | XND0000324 | |  |
| | Sklo PS 90, 8-1947x420 LB-7571 | 1 | XND0000325 | | |
| 5 | Vrut 4x30 LF-0214 | 4 | XND0000093 | |  |
| 6 | Hmoždinka 6 LP-8949 | 5 | XND0000061 | |  |
| 7 | Krytka vnitřní L,R LP-4639,LP-4640 | 1+1 | XND0000274 | XND0000347 |  |
| 8 | Vodící profil 80 BRA-10622 | 2 | XND0000296 | XND0000384 |  |
| | Vodící profil 90 BRA-10623 | 1 | XND0000306 | XND0000385 | |
| 9 | Šroub M4x6 LF-0059 | 2 | X90085040060 | |  |
| 10 | Rohová koncovka LP-4638 | 1 | XND0000297 | XND0000386 |  |
| 11 | Okapnička 80-418 BRJ-4358 | 1 | XND0000298 | XND0000387 |  |
| | Okapnička 90-468 BRJ-4360 | 1 | XND0000318 | XND0000388 | |
| 12 | Doraz kolečka L,R LP-2870,LP-2871 | 1+1 | XND0000277 | XND0000357 |  |
| 13 | U profil montážní LC-1244 | 2 | XND0000319 | |  |
| 14 | Pojezdové kolečko LL-8327 | 2 | XND0000278 | XND0000358 |  |
| 15 | Madlo dveří LS-8326 | 1 | XND0000279 | XND0000359 |  |
| 16 | Krytka madla LP-2965 | 2 | XND0000280 | XND0000360 |  |

| RORV2 - 80, 90 | | | | | |
|-----------------------|-----------------------------------|----------------|-----------------|------------|--|
| Číslo dílu: | Název: | Množství [ks]: | SIČ bright alu: | SIČ black: | Obrázek: |
| 17 | Sklo dveří 80, 8-1926x418 LB-7860 | 1 | XND0000335 | |  |
| | Sklo dveří 90, 8-1926x468 LB-7570 | 1 | XND0000336 | | |
| 18 | Těsnící profil dveří LC-1249 | 1 | XND0000281 | XND0000361 |  |
| 19 | Magnet-dveře 1926 LC-8160 | 1+1 | XND0000299 | XND0000389 |  |
| 20 | Spojka konzoly LW-4511 | 1 | XND0000300 | XND0000390 |  |
| 21 | Šroub M4x8 | 2 | X90914040080 | |  |
| 22 | Krytka vzpěry LP-2872 | 2 | XND0000282 | XND0000362 |  |
| 23 | Vzpěra 80 BRP-4681 | 1+1 | XND0000301 | XND0000391 |  |
| | Vzpěra 90 BRP-4683 | 1+1 | XND0000302 | XND0000392 | |
| 24 | Konzola LW-1082 | 2 | XND0000290 | XND0000378 |  |
| 25 | Pouzdro na tyč LP-8967 | 4 | XND0000291 | XND0000379 |  |
| 26 | Podpora BRP-4669 | 2 | XND0000292 | XND0000380 |  |
| 27 | Vrut 4x40 LF-0224 | 2 | X90085040094 | |  ST4x40 |
| 28 | Těsnící profil PS LC-1276 | 1 | XND0000284 | XND0000364 |  |
| 29 | Podložka pod vrut LP-2259 | 8 | XND0000090 | |  |









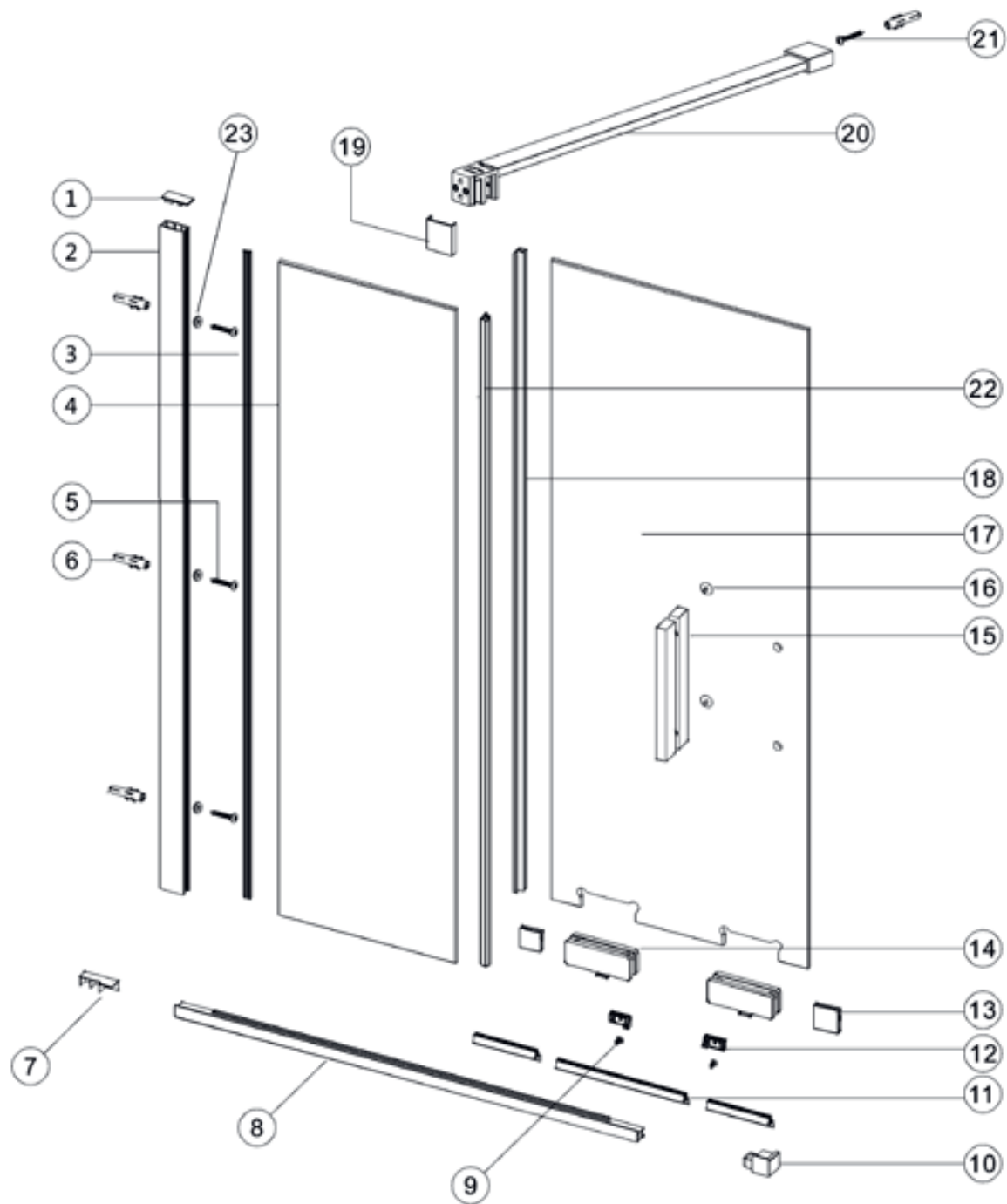







ROPS – 80, 90, 100









| ROPS – 80, 90, 100 | | | | | |
|---------------------------|-------------------------------------|----------------|-----------------|------------|---|
| Číslo dílu: | Název: | Množství [ks]: | SIČ bright alu: | SIČ black: | Obrázek: |
| 30 | krytka ustavovacího profilu LP-2140 | 1 | XND0000270 | XND0000344 |  |
| 31 | Ustavovací profil 1950 BRA-10612 | 1 | XND0000271 | XND0000345 |  |
| 32 | Těsnící profil skla 2000 LC-8799 | 1 | XND0000272 | XND0000346 |  |
| 33 | Hmoždinka 6 LP-8949 | 4 | XND0000061 | |  |
| 34 | Vrut 4x30 LF-0214 | 4 | XND0000093 | |  ST4x30 |
| 35 | Sklo PS 80, 8-1949x748 LB-9028 | 1 | XND0000326 | |  |
| | Sklo PS 90, 8-1949x848 LB-9029 | 1 | XND0000327 | | |
| | Sklo PS 100, 8-1949x948 LB-9027 | 1 | XND0000328 | | |
| 36 | Rohová koncovka L,R LP-2993,LR-2994 | 1+1 | XND0000293 | XND0000381 |  L R |
| 37 | Profil s magnetem LC-8638 | 1 | XND0000294 | XND0000382 |  |
| 38 | Podložka pod vrut LP-2259 | 4 | XND0000090 | |  |
| 39 | Držák skla PS LW-1420 | 1 | XND0000295 | XND0000383 |  |

ROVS2 - 100, 110



| ROVS2 - 100, 110 | | | | | |
|-------------------------|-------------------------------------|----------------|-----------------|------------|---|
| Číslo dílu: | Název: | Množství [ks]: | SIČ bright alu: | SIČ black: | Obrázek: |
| 1 | krytka ustavovacího profilu LP-2140 | 1 | XND0000270 | XND0000344 |  |
| 2 | Ustavovací profil 1500 BRA-10632 | 1 | XND0000269 | XND0000343 |  |
| 3 | Těsnící profil skla 1550 LC-8799 | 1 | XND0000272 | XND0000346 |  |
| 4 | Sklo PS 100, 8-1497x490 LB-9031 | 1 | XND0000329 | |  |
| | Sklo PS 110, 8-1497x540 LB-9033 | 1 | XND0000330 | | |
| 5 | Vrut 4x30 LF-0214 | 4 | XND0000093 | |  ST4x30 |
| 6 | Hmoždinka 6 LP-8949 | 5 | XND0000061 | |  |
| 7 | Krytka vnitřní L,R LP-4639,LP-4640 | 1+1 | XND0000274 | XND0000347 |  L+R |
| 8 | Vodící profil 100 BRA-10626 | 1 | XND0000273 | XND0000348 |  |
| | Vodící profil 110 BRA-10627 | 1 | XND0000307 | XND0000349 | |
| 9 | Šroub M4x6 LF-0059 | 2 | X90085040060 | |  M4x6 |
| 10 | Rohová koncovka L,R LP-2990,LP-2989 | 1+1 | XND0000275 | XND0000352 |  |
| 11 | Okapnička 100 BRJ-4369 | 1 | XND0000276 | XND0000353 |  |
| | Okapnička 110 BRJ-4370 | 1 | XND0000312 | XND0000354 | |
| 12 | Doraz kolečka L,R LP-2870,LP-2871 | 1+1 | XND0000277 | XND0000357 |  L+R |
| 13 | U profil montážní | 2 | XND0000319 | |  |
| 14 | Pojezdové kolečko LL-8327 | 2 | XND0000278 | XND0000358 |  |
| 15 | Madlo dveří LS-8326 | 1 | XND0000279 | XND0000359 |  |
| 16 | Krytka madla LP-2965 | 2 | XND0000280 | XND0000360 |  |

| ROVS2 - 100, 110 | | | | | |
|-------------------------|------------------------------------|----------------|-----------------|------------|---|
| Číslo dílu: | Název: | Množství [ks]: | SIČ bright alu: | SIČ black: | Obrázek: |
| 17 | Sklo dveří 100, 8-1476x523 LB-9030 | 1 | XND0000337 | |  |
| | Sklo dveří 110, 8-1476x573 LB-9032 | 1 | XND0000338 | | |
| 18 | Těsnící profil dveří LC-1249 | 1 | XND0000281 | XND0000361 |  |
| 19 | Krytka vzpěry LP-2872 | 1 | XND0000282 | XND0000362 |  |
| 20 | Vzpěra BRP-4698 | 1 | XND0000283 | XND0000363 |  |
| 21 | Vrut 4x40 LF-0224 | 1 | XND0000094 | |  |
| 22 | Těsnící profil PS LC-1276 | 1 | XND0000284 | XND0000364 |  |
| 23 | Podložka pod vrut LP-2259 | 4 | XND0000090 | |  |

RAVAK a.s., Obecnická 285, 261 01 Příbram I, ČR
tel.: +420 318 427 111, fax: +420 318 427 278. e-mail: info@ravak.cz, web: www.ravak.cz

RAVAK SLOVAKIA spol. s r.o., Einsteinová 11, 851 01 Bratislava
tel.: +421 2 / 444 550 01, fax: +421 2 / 444 550 02, e-mail: obchod@ravak.sk, web: www.ravak.sk

RAVAK POLSKA S.A., Kałęczyn, ul. Radziejowicka 124, 05-825 Grodzisk Mazowiecki, POLSKA
tel.: 22 / 755 40 30, fax: 22 / 755 43 90, e-mail: info@ravak.pl, web: www.ravak.pl

RAVAK Hungary Kft., 1142 Budapest, Erzsébet királyné útja 125, HUNGARY
tel.: 06 (1) 223 13 15, 06 (1) 223 13 16, fax: 06 (1) 223 13 14, e-mail: info@ravak.hu, web: www.ravak.hu

Ravak Gesellschaft für Sanitärprodukte mbH, Alexanderstrasse 58, D - 45472 Mülheim an der Ruhr
Tel. (0208) 37789-30 Fax. (0208) 37789-55, e-mail: info@ravak.de, web: www.ravak.de

RAVAK a.s., Representative Office in Ukraine, 21 Dniprovska Naberezhna str., 2nd floor, 02081, Kyiv, Ukraine
tel.: 00380 44 2203232, 00380 44 3605200, fax: 00380 44 2204343, e-mail: ravak@ravak.kiev.ua, web: www.ravak.ua

OOO RAVAK ru. ul. Staropetrovskiy pr. 7A, Moskva 125 130,
tel./fax: 007 495 710 82 23, 007 495 450 12 77, e-mail: ravak@inbox.ru, web: www.ravak.com

RAVAK®

RAVAK a.s., Obecnická 285, 261 01 Příbram I
tel.: +420 318 427 200, +420 318 427 111 fax: +420 318 427 269
info@ravak.cz, www.ravak.com

Výrobce si vyhrazuje právo změny ceny, technických parametrů, či dalších skutečností
bez předchozího upozornění a nenese odpovědnost za tiskové chyby.